

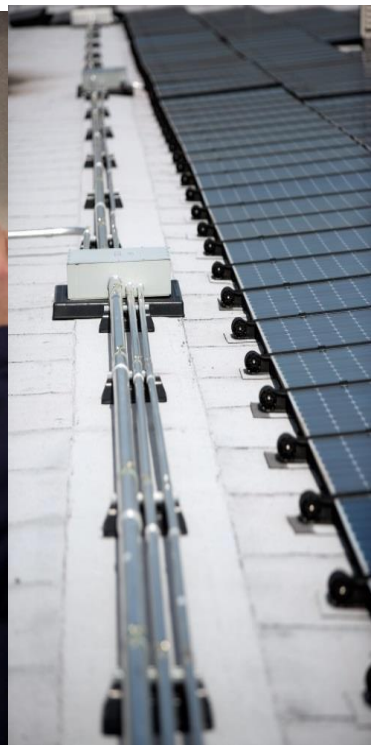

# Solar Photovoltaics Guide

Version 5 / July 2022



**LEGAL DISCLAIMER:** This guide is for informational purposes only and does not constitute legal advice. This does not substitute for any applicable laws, rules or regulations, tariffs, and/or specifications. Further, any information is subject to change without notice. To the extent there is any conflict between this guide and any applicable laws, rules, regulations, tariffs, and/or specifications, the applicable laws, rules, regulations, tariffs, and/or specifications control. Consolidated Edison Company of New York shall not be held liable for indirect, special, incidental, punitive, or consequential damages of any kind, including loss of profits, arising under or in connection with this guide.

**COMPANY REVIEW:** The Company's shall review the Customer's design at various stages of the design as well as during construction. The Company's review is for general arrangement and conformity with the Company's interconnection requirements only and does not indicate safe or faultless design. Company review of the final plans or drawings indicates that the design is compatible with Company equipment and service. Responsibility for proper design, operation, maintenance and safety of the Customer's installation rests solely with the Customer. In addition, all work and equipment must conform to municipal and all other applicable codes and requirements, including applicable provisions of the National Electrical Code (NEC), the National Electrical Safety Code (NESC) and OSHA in effect at the time of construction.

## Table of Contents

<a href="#">Introduction</a> .....	4
<a href="#">About Con Edison's Electrical Grid</a> .....	4
<a href="#">Technical Interconnection Considerations for PV system</a> .....	5
<a href="#">SCADA Equipment Details</a> .....	7
<a href="#">Interconnection Process</a> .....	8
<a href="#">Rates and Service Classifications</a> .....	13
<a href="#">Solar Paired with Other Technologies</a> .....	18
<a href="#">Contacts for Further Questions</a> .....	19
<a href="#">Definitions and Acronyms</a> .....	19
<a href="#">List of Figures</a> .....	20

## Consolidated Edison Company of New York: Guide to Solar Interconnection

### Introduction

This guide is for Con Edison Customers who are considering installing or upgrading photovoltaic (PV, aka solar) power generators less than 5MW-AC that are or will be connected to Con Edison's electric distribution system.

Interconnection of Distributed Energy Resource technology such as PV less than or equal to 5 MW are subject to the New York State [Standardized Interconnection Requirements \(SIR\)](#) . All developers and applicants should read the SIR as the SIR will take precedence. This document is aligned to the May 2022 version of the SIR, and later revisions of the SIR will be integrated as expediently as possible.

This guide is intended to provide high level details of the electric interconnection process, typical steps, challenges, and technical solutions associated with PV projects. This guide is not a design or technical specification.

This guide is intended for installations up to 5MW-AC, which is the current per-premise cap for Value Stack credits in New York State. For questions on projects above 5MW-AC, please contact [dgexpert@coned.com](mailto:dgexpert@coned.com).

### Section 1: About Con Edison's Grid

Con Edison provides electric services to 3.4 million customers in New York City and portions of Westchester County. Electricity is delivered through approximately 94,000 miles of underground cable, and almost 37,000 miles of overhead cable.

The distribution system supplies power to the company's low voltage network customers and radial customers from area substations at the 4kV, 13kV, 27kV, and 33kV primary service voltage levels. The majority of customers receive low tension (low voltage) service directly at the distribution system secondary voltage levels of 120/208V; 120/240V or 265/460V, while a small percentage of high tension (high voltage) customers receive power at primary service voltage levels.

There are two types of electric distribution grid systems: radial grids and network grids.

**Radial Grids** traditionally have a single high voltage cable, often referred to as a feeder, sending energy from the substation to numerous distribution transformers tapped at various points along its length. The distribution transformers step the voltage down to low-voltage electricity. These systems are called radial grids because the substation and feeders resemble a hub with spokes. Cables and transformers on radial grids are often above ground, seen predominantly in areas like Staten Island or Westchester.

Con Edison uses a reliable type of radial grid called an "auto-loop". An auto-loop typically has two feeders, two additional backup feeders, and automatic switches at various points along the feeder. In this configuration, feeder faults are rapidly isolated, with a portion of the affected customers being restored with one of the aforementioned backup feeders.

**Network Grids** have multiple primary feeders supplying several network transformers. They are tied together in parallel on the secondary side to provide energy into a low voltage grid (area network type) or a local building bus (spot network) where the consumer is connected. Thousands of low voltage customers are served off the low voltage grid of an area network. Cables and transformers on network grids are typically below ground and are used in densely populated areas. Network grids are used extensively throughout Manhattan, Brooklyn, Queens, and the Bronx, in addition to several small network grid areas in Staten Island and Westchester.

The different grid configurations have different associated characteristics. Network grids are considered more reliable than radial grids as there are redundant sources of backup power in case of failures on the grid. Additionally, with cables and transformers mostly underground, network grids tend to be less prone to outages resulting from severe weather conditions than above ground radial grids. Network grids are more complex than radial grids due to the increased number of system components and the redundant cabling.

Spot networks are a special class of network grids where one or multiple transformers are dedicated to a single, large energy consuming building like a skyscraper. A spot network is essentially a small network grid that is implemented for a single large user. Both the radial and network grids are represented in Figure 1, below:

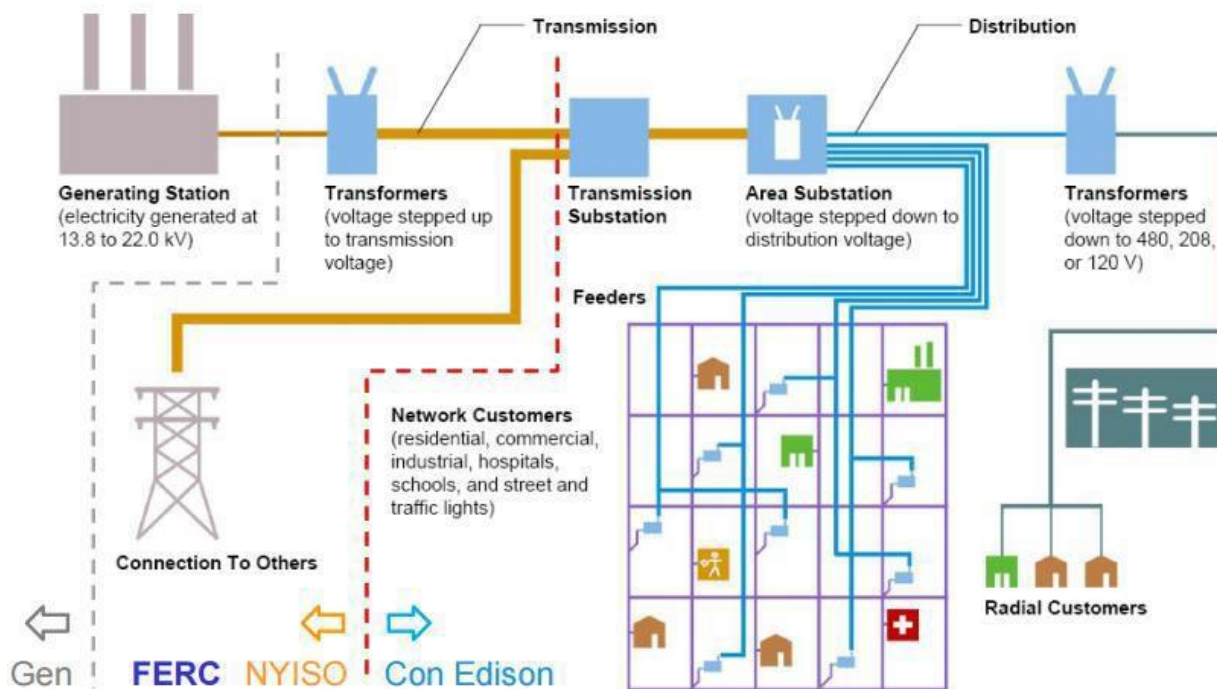

Figure 1 - Electric Distribution System

## Section 2: Technical Interconnection Considerations for PV system

Con Edison manages the interconnection of photovoltaic (PV) generation less than 5MW-AC in capacity under the [Standardized Interconnection Requirements \(SIR\)](#). Please note that Net Metering in New York State is limited to projects 5MW-AC and below. The SIR draws a distinction between projects greater than and less or equal to than 50kW-AC. The vast majority (approximately 98% at the time of this publication)

of jobs are small scale (< 50kW-AC) residential solar jobs. Solar project 50kW-AC and lower are self-certified by the applicant.

PV systems are typically designed to export power at least some of the time. The export of power can cause undesirable system impacts, such as voltage fluctuation or the repetitive operation of network protector relays, particularly for larger systems more than 50kW-AC. The technical considerations for accommodating large PV systems will vary depending on the type of electrical distribution service (e.g., radial, network) at the point of interconnection as well as any surrounding loads.

#### Radial Service

Interconnecting exporting PV generation to a radial service can be limited by the capacity of the local service, the primary feeder, the capability of a unit substation to accept reverse power flow, or switch and re-closer issues. The methods of resolving these constraints vary in complexity and cost.

#### Network Service

With network service, if one of the primary feeders supplying a portion of the network grid's transformers were to experience an outage, the parallel connected secondary grid will try to provide power into the dead feeder. For this reason, these transformers are designed with an automatic switch, known as a network protector, which will open when energy feeds back from the low voltage bus toward the high-voltage feeder outage. This is the same condition as when a large PV system provides more power into the area network grid or spot network than there is load to serve. While Con Edison's dense network grid system typically has enough load to "soak up" the exported power, the electric system can be adversely affected by the back-feed of power.

For applicants connecting to Con Edison's secondary grid, the engineering review will determine if the service cable to the site is adequate to carry the export, in addition to determining if export into the network will cause network protector operation. If the service cable is not rated for the expected solar export capacity, the customer will need to upgrade the existing service or put in an additional service. For those projects where local network protectors will be impacted, Con Edison has a solution called "Adaptive Network Protector (NWP) Relay Settings" where modifications are made to the relays of nearby transformers.

In addition, in some cases the export of power from the PV system can cause overvoltage and/or power quality issues. In these cases, Con Edison can deploy Communication Aided Tripping (described below) to help keep select NWP relays closed and provide greater voltage stability. However, in some cases, Con Edison will also need to rely on the inverter itself to help regulate voltage. This generally requires the inverter to consume VARs at a fixed power factor, or better still utilize the "Advanced" inverter features as outlined in the IEEE 1547 specification (Volt-VAR and Volt-Watt Characteristics) with settings recommended by Con Edison. When the inverter is required to prevent overvoltage, the function shall be "supervised" by a utility grade overvoltage relay. Additionally, Con Edison requires communications be established to any inverter managing voltage by consuming VARs to ensure voltage is maintained within ANSI limits.

### Spot or Isolated Networks

For customers on dedicated spot or isolated networks, the opening of a network protector would result in a loss of power to the customer. Con Edison's traditional approach to maintain reliability for customers wanting to install solar on a spot or isolated network would be to require a reverse power relay that would prevent export. Since 2012, Con Edison has begun offering solutions to enable export across network protector relays through pilot programs, making it the only utility in the nation to allow export on network service. This solution is called "Communications Aided Tripping" (CAT) and it involves the following:

1. Reducing sensitivity on local network protectors – Reprogramming network protectors to an "insensitive" mode that allows back-feed of up to 50% of the transformer rating.
2. Supervisory Control and Data Acquisition (SCADA) and anti-islanding – Installing equipment to monitor the performance of the solar generator and the network protectors and allow for remote tripping in the event of system contingencies and/or outage risk to the customer.

The solutions offered will be tailored to the specific service configurations. Costs for CAT will be project specific and determined by our engineering team and the Customer Project Manager (CPM) who assigned for your project but very generally can be in the range of \$100,000. <sup>1</sup> The reduced sensitivity solution on local network protector relays is more suitable for interconnections to the low voltage grid, whereas the communication-aided tripping is more suitable for isolated or spot networks.

### Equipment Details

The following list of equipment may be required (and installed as needed) for Con Edison PV projects, particularly those using the CAT solution. The exact requirements and specifications of the equipment will be determined during the engineering review and site visits.

The customer is responsible for the cost of procuring and installing this equipment, regardless of whether the customer or Con Edison is installing it.

- **Supervisory Control and Data Acquisition (SCADA):** This equipment collects data from the customer's inverters and Con Edison's network protectors. In addition to providing communications, SCADA also allows for remote operations and controls of the network protectors.
- **Anti-islanding device:** This equipment is sometimes required, based on a case-by-case assessment of solar system size and the type of service to the customer. The purpose of this device is to ensure that solar export does not cause a customer outage if one or more feeders go out of service.
- **DNP3 Data Concentrator for data link communication:** DNP3 communication protocol is required to ensure reliable, and consistent communication between customer's inverters and Con Edison. This can be achieved by customer installing DNP3 compliant Data Concentrator for Con Edison to adequately monitor customer equipment and issue controls. A DNP3 converter card will be

---

<sup>1</sup> This is an estimate only. Project costs can be higher or lower depending on project specifics. Customers should not rely on this number before they receive actual costs and written design approval from Con Edison.

required if the customer Control System is MODBUS. The customer is responsible for ensuring availability of a DNP3 protocol in their Control System.

- **Network protector micro-processor relay and associated cabling:** A device to remotely monitor the operations of the network protector. This is required to enable two-way communications. Con Edison network protectors are typically installed with a standard non-communicating relay and must be upgraded for participation in this program. Con Edison will install the relays and connect any required cables within Con Edison's jurisdiction.
- **Conduits & Cables:** Cables and conduits will be run between the communications and protective equipment. The customer will be required to provide their own communications cable which specified by Con Edison engineering design. The customer will make the connections and bring the cable to Con Edison's jurisdiction, who will then connect the PV to the relays to complete the installation. New conduits may be required, depending on existing site conditions

### Section 3: Interconnection Process

As noted above, Con Edison follows the New York State SIR to review and approve all solar projects up to 5MW-AC. Prior to application submittal, please read the SIR thoroughly to familiarize yourself with application process and timelines, technical and operating requirements, and required contracts and forms. In advance of application submission please review Rider R, which is the Net Metering and Value Stack tariff for Con Edison (discussed further in Section 4), and register with Power Clerk. The [Small DG portal](#) should be used for Interconnection requests less than or equal to 50kW-AC. The [Large DG portal](#) should be used for Interconnection requests greater than 50kW-AC. The SIR only applies for projects up to 5MW-AC. For projects seeking interconnection to the distribution system not under the SIR jurisdiction, please contact [dgexpert@coned.com](mailto:dgexpert@coned.com) for more guidance.

Taking the following steps prior to and during the application submission will help speed up the review:

1. Include accurate account (14 digit) and meter (7 digit) numbers.
  - a. Use host account detail for Remote Crediting (RC) and Community DG (CDG) projects.
2. Include accurate customer email address.
3. Include the Con Edison service information in all drawings.
4. Include additional existing on-site Distributed Energy Resources (DER) in the application.
5. Enter the rating per inverter and number of inverters.
6. Ensure consistency in all forms and documents.

When an application is ready for submission, the applicant should upload all documents listed in [Appendix F of the SIR](#). The applicant should also include any additional rate application forms (Form G or Community DG Appendices A and B, as applicable).

Additional technical information may be required if the application progresses to a Coordinated Electric System Interconnection Review (CESIR).

To provide guidance in preparing materials for PV applications, Con Edison has prepared checklists for three-line diagrams and field verification tests. These checklists can be found on the [Con Edison DG](#)

[website](#) and provide requirements for system diagrams and verification tests, as well as consistency in reviews from project to project.

Examples of some of the features that should be called out on the three-line diagram are shown in Figures 2 and 3 below:

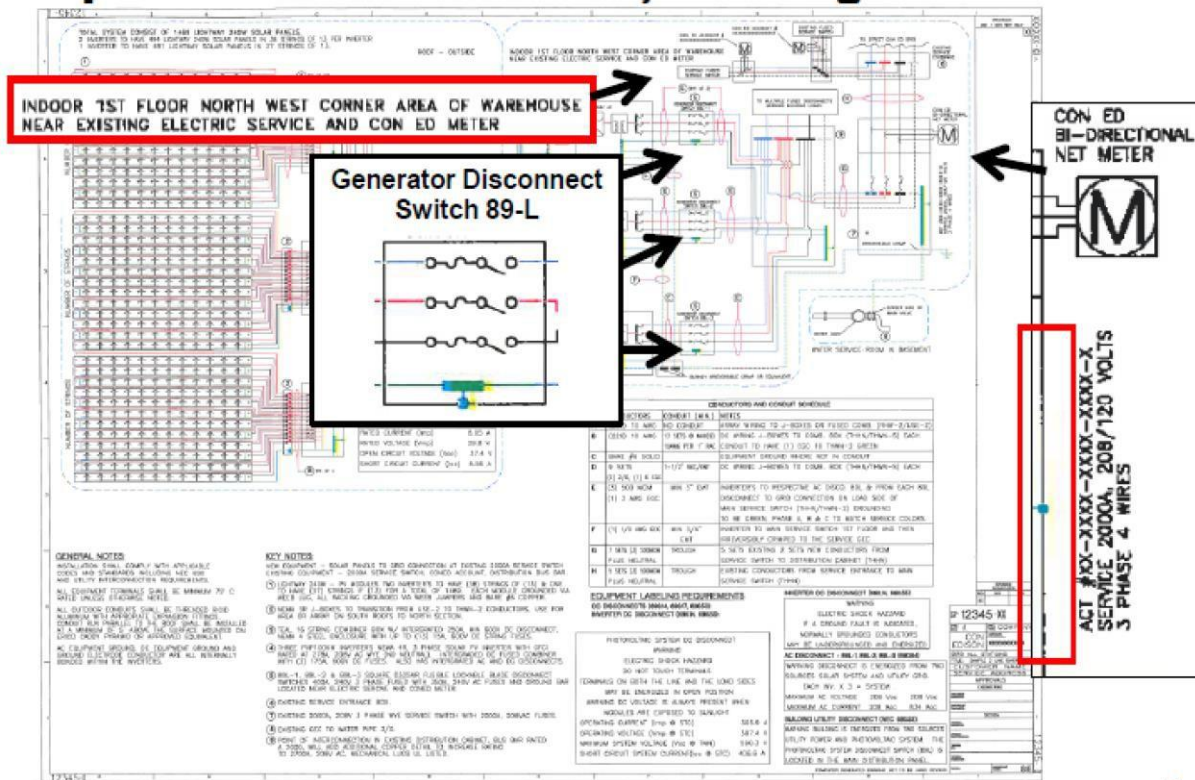

Figure 2 - Disconnect Switch and Existing Service clearly labelled

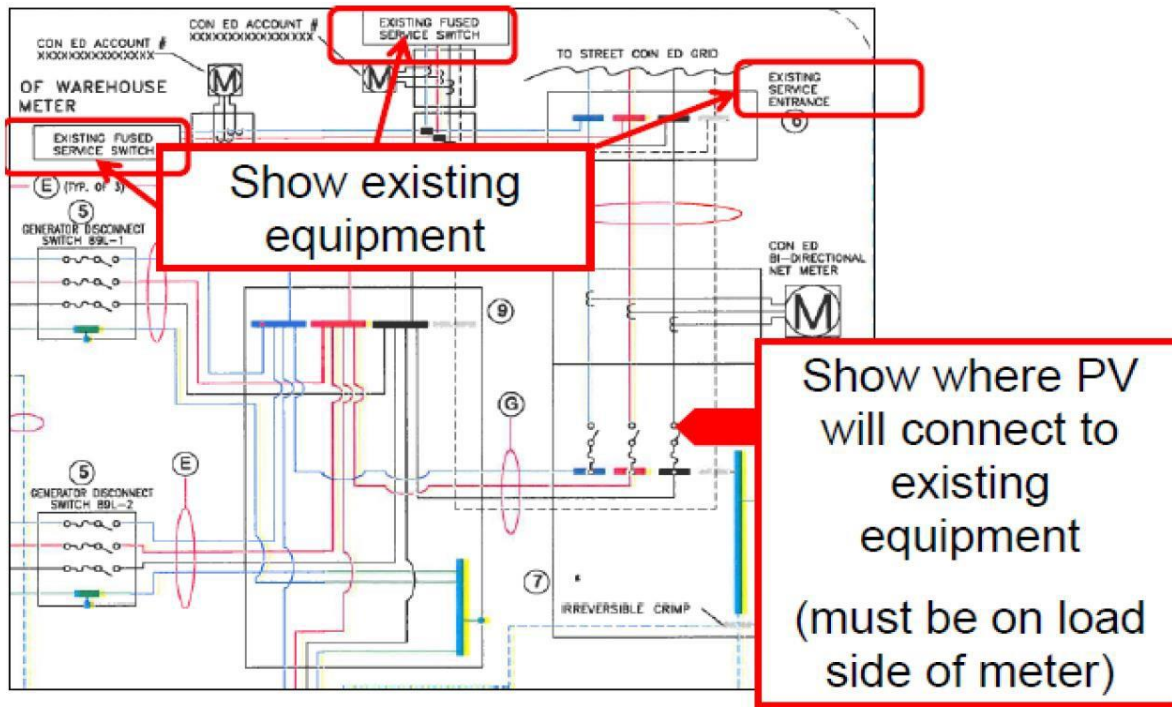

Figure 3 - Existing equipment and interconnection location clearly labeled

After logging into Power Clerk, the relevant customer and project information should be entered with the documents described above and attached when prompted. Once all information is entered or attached and submitted, the application will be routed to the appropriate Con Edison Energy Services personnel and the application review will begin. The SIR process is different for small (< 50kW-AC) and large ( $\geq$  50kW-AC) projects.

#### Small Projects (less than or equal to 50kW-AC) Process

For projects up to 50kW-AC, after the application is submitted, the applicant can expect the following to happen:

1. Con Edison will review the diagram and issue a line diagram approval letter if all documents have been submitted and are complete.
2. The applicant/contractor will complete construction.
3. The applicant/contractor will test the inverter.
4. The applicant/contractor will submit the [self-certification form](#) by uploading through Power Clerk.
5. Con Edison will perform final review and place net meter order and issue the final acceptance letter.

#### Large Projects (greater than 50kW-AC) Process

The application process for projects greater than 50kW-AC up to 5MW-AC includes more complex applicant choices and utility responses as described by the flowchart in Figure 4. If any project is greater than 5MW-AC, it will not fall under the SIR and has a separate application process and project timeline.

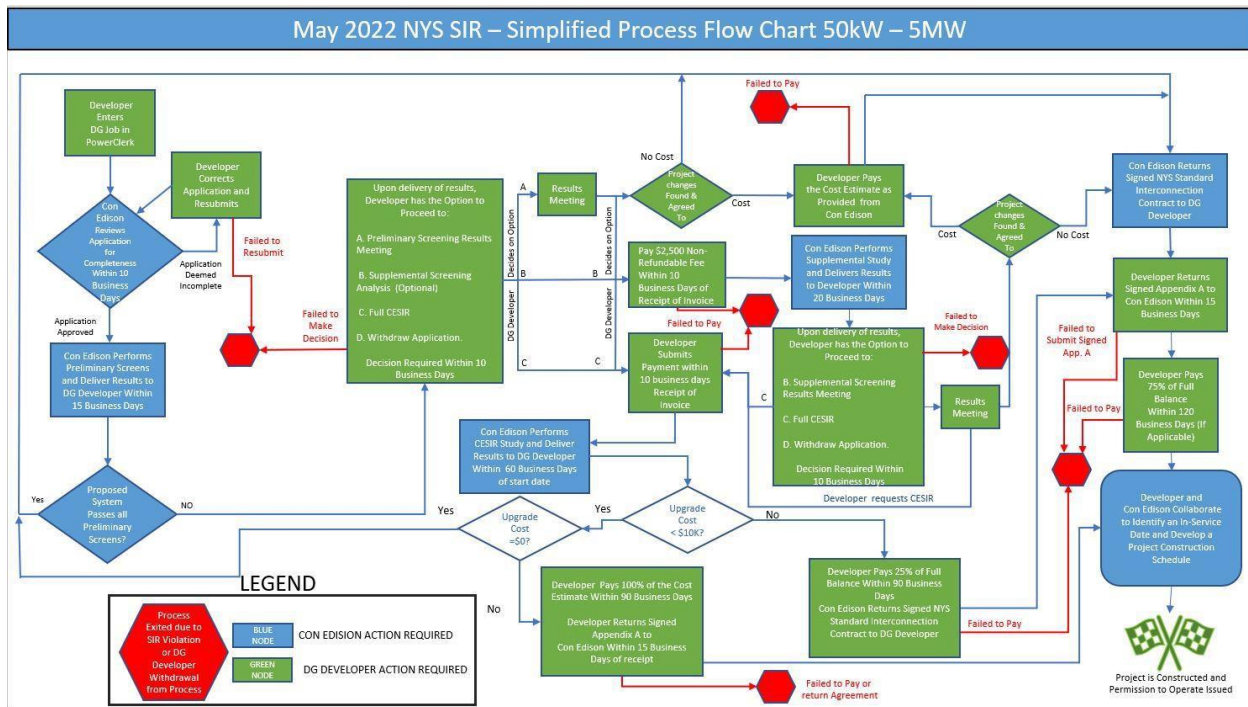

Figure 4 -Interconnection application process for 50kW to 5MW projects.

The general steps in the process include:

1. Applicant submits Pre-Application Report request (Optional/\$750 Report Fee).
2. Con Edison returns the Pre-Application Report (10 Business Days).
3. Applicant submits an application.
4. Con Edison reviews the application for completeness (10 Business Days).
5. Con Edison performs preliminary screening analysis (15 Business Days).
  - a. If application passes the six preliminary screens, Applicant proceeds to construction.
6. Applicant selects additional review/meeting option (Note: this can be an iterative process. The Decision is required within 10 Business Days).
  - a. Preliminary analysis results meeting to explain screening process and identify any simple changes that could lead to the project being approved.
  - b. Supplemental Screening Analysis, at customer choice of this option, to perform three additional screens, which if passed progress the application to.
  - c. CESIR, at customer choice of this option, to perform in depth analysis of the proposed DG system to determine the system changes and cost estimates needed to accommodate interconnection. Cost is dependent upon size, operation, type of electric distribution service, and type of equipment. Numbers may vary slightly for high-tension service but are in a similar range.
  - d. Withdraw/cancel – the applicant has the option to withdraw or cancel their application at any time.
7. Con Edison performs requested review (See Figure 4 for details).

8. If applicable, applicant commits to construction costs. For Projects costing \$10,000.00 or less, the developer is required to provide full payment within 90 business days, and projects costing more than \$10,000.00, the developer is required to pay 25% of the full balance within 90 business days with the remaining 75% of the full balance due within 120 business days.
9. Applicant and Con Edison complete their respective construction.
10. Con Edison performs field verification testing.
11. If applicable, Applicant addresses any issues emerging from the field verification testing and Con Edison issues final acceptance letter or Permission to Operation Letter.

**Note on failed inspections:**

If you disagree with a failed inspection, send an email to your CPM, your engineer, and the email address [dl-DGinspectionappeal@coned.com](mailto:dl-DGinspectionappeal@coned.com). This email goes to Energy Services and Distribution Engineering senior managers. The email subject line should include the case number and "Appeal of Verification Test". The email should describe in detail, as related to the verification test checklist, why you disagree with the results of the inspection. Include any documentation or photographs that are necessary. In addition, upload the email to the case in Power Clerk.

You will receive an acknowledgement of your appeal in 2 business days via email, and Con Edison will respond with a resolution and rationale within 10 business days.

**Note on solar projects that are applying for mostly Value Stack credits to other facilities:**

Community Distributed Generation (CDG) projects may be designed to export most of their capacity by installing the project behind an existing or new meter. If choosing to apply for a new service, in Power Clerk the applicant should select "No" for "Is there an existing service at the site of the proposed DG project?" on page 1 of the application. Please note in your scope of work that you may need to request a new meter. The engineering review will determine if the existing service to the building can carry out the export or if a new physical service will be needed.

**Note on solar projects that will require an outage to interconnect their project:**

If the project requires an outage for interconnection, please work with the CPM to coordinate this outage request. It is important to note that Con Edison crews will be available at no charge during regular business hours: Monday-Friday, 7:00am – 3:00pm excluding holidays. However, if you request an outage outside of these normal working hours, or if the outage extends beyond 3:00pm, you will be responsible for full payment of the cost for time spent outside working hours, including overtime etc.

### **Note on placement of customer equipment relative to Con Edison revenue metering compartment:**

The Con Edison revenue metering compartments represent the dividing point between Customer equipment and Con Edison's system. Customer equipment is not to be installed, nor are any customer connections to be made, inside Con Edison's metering compartment.

### Roles and Responsibilities

Throughout the interconnection process, applicants will interact with a number of Con Edison personnel with various roles and responsibilities, including:

- **Distributed Energy Services Customer Project Manager (CPM)** – Primary point of contact for all communication, scheduling of inspections and overall process oversight for your project
- **Distribution Engineering** – Electrical interconnection experts for Con Edison who perform the technical document reviews, perform the Supplemental Review and CESIR studies, attend technical meetings, witness verification testing and perform the final inspection.
- **Distributed Generation Ombudsman** – An additional layer of assistance in understanding the Con Edison interconnection process, tariff interpretations, and new policy implications which can be leveraged even prior to commencing your solar projects. The Ombudsman's office can also provide assistance on any unresolved project-specific issues.
- **Customer Care Group** – Handles Net Metering billing and post-installation billing questions

### **Section 4: Rates and Service Classifications**

The service classifications for customers typically installing solar generation include the following. Con Edison assigns the service class based on the customer characteristics:

#### Mass Market

##### **Service Class 1 (SC1) - Residential/Religious**

This rate is for residential customers. It is volumetric billing based on energy usage (kWh). SC 1 customers have no demand charge.

##### **Service Class 2 (SC2) - General – Small**

This rate is for small commercial customers with demand less than 10kW. It is also volumetric billing based on energy usage (kWh). SC 2 customers have no demand charge.

#### Large Onsite

##### **Service Class 8 (SC8) - Multiple Dwellings**

This rate is for master-metered residential customers. It includes energy usage (kwh) billing with a variable demand charge (kW), adjusted monthly based on the highest 30 minutes of demand

##### **Service Class 9 (SC9) General Large**

This rate is for large commercial customers with demand 10kW or larger. It is energy usage (kwh) billing with a variable demand charge (kW), adjusted monthly based on the highest 30 minutes of demand

These service class distinctions will determine how the credits are applied, as will the specific solar eligible program: Phase One Net Metering, Value Stack, Remote Crediting, or Community Distributed Generation. All configurations use a variant of applying the excess generation from one solar system across one or multiple accounts.

### Value of Distributed Energy Resource (VDER)

On March 9, 2017 the New York State Public Service Commission (PSC) released an order to transition away from net energy metering (NEM) to VDER.

### Grandfathered NEM

Customers with Solar PV installed before March 9, 2017, receive NEM for the life of the system.

Under Grandfathered NEM, excess solar credits are cashed out every January by default. A Grandfathered NEM customer may make a onetime election to change the cash out month. Most customers choose to cash out their solar banks during a month when they anticipate having the fewest solar credits because the cash-out value—the avoided cost of energy—is less than the value of applying your solar credits to your energy consumption. For this reason, it is recommended that you monitor your energy use for a full year before changing your cash out month.

Existing NEM customers may opt into Value Stack.

### Phase One NEM

Mass Market customers with solar installed after March 9, 2017 as well as Large On-Site customers with solar that has a rated capacity of 750kW-AC AC or lower and installed on/after June 1,2019 receive Phase One NEM compensation unless they choose to opt-in to Value Stack rates. Phase One NEM is similar to Grandfathered NEM with the following differences:

- Credits carry over month-to-month and year-to-year; there is no annual cash-out

**Electricity you used during this 30 day billing period  
from Jan 20, 2016 to Feb 19, 2016**

**Rate:** EL1 Residential or Religious - Net Metering **Meter#** [REDACTED]

We measure your electricity by how many kilowatt hours (kWh) you use.  
One kWh will light a 100 watt bulb for 10 hours.

Feb 19, 16 actual reading	3993
Jan 20, 16 actual reading	<u>-4057</u>
<b>Your electricity use</b>	<b>-64 kWh</b>
<b>kWh Billed</b>	<b>0 kWh</b>

For details, see Your Net Meter Summary in this bill.



Figure 5 - Example of Grandfathered or Phase One net meter credited bill

### Community DG

Community Distributed Generation (CDG) describes the configuration when Value Stack Net Metering credits from one solar system (the host) are distributed to multiple different customers (the satellites). For a customer to be eligible for CDG, several conditions must be met:

- The host account must be non-residential
- Host and satellite accounts can be in different NYISO zones within Con Edison service territory
- At least 10 satellite customers unless all are located at the same premise as the host
- Each customer must have at least 1,000kW-ACH annual usage
- Satellite customers above 25kW-AC can take up no greater allocation than 40% of the Net Metering credits
- Potential service upgrades required to accommodate export
- Use [Community DG Procedural Document](#) for application, which requires self-certification of creditworthiness, cyber security, NYISO load zone, and any other obligations

### Remote Net Metering

The general process and application of remote Net Metering is described below. The rates will be governed by the tariff and specific questions can be directed to your project manager or the DG ombudsman.

Remote Net Metering describes the configuration when Value Stack credits produced by one solar system (the host) are distributed to the same customer's multiple accounts on different locations (the satellite(s)). For a customer to be eligible for Remote Net Metering, several conditions must be met:

- Only available to existing remote net metered Grandfathered Net Metering and Phase One NEM customers, their successor accounts, as well as new and existing net metered wind customers
- The host account must be non-residential
- The host account and satellite account must be different and shall be established in the same customer's name and located on property owned or leased by the customer
  - Satellite accounts can have more than one host account
- Host and satellite accounts must be located within the same NYISO zone within Con Edison service territory
- Starting September 1, 2021, all existing RNM projects interconnected prior to this date, who received Value Stack credits were transitioned to the Remote Crediting program and will continue to receive Value Stack credits. Value Stack RNM is no longer available for non-wind customers.
- Other requirements specified in Rider R, Section A Applicability (e.g., system size)

### Remote Crediting

Remote crediting describes the configuration when Value Stack credits produced by one solar system (the host) are distributed to multiple different customers (the satellite(s)). For a customer to be eligible for remote crediting, several conditions must be met:

- Taking Value Stack service

- The host account must be non-residential or residential with Farm Operations
- Host and satellite accounts can be located in different NYISO zones within Con Edison service territory
- Form G must be used for the application
- Host account must submit an allocation form

#### Net Crediting Program

A voluntary program offered by the Company to CDG Hosts. The Net Crediting Program authorizes the Company to remit payments to the CDG Host on behalf of CDG Satellites, resulting in a net credit on the CDG Satellite's Electric Bill.

Click the following link for more information on how to enroll in the [net crediting program](#).

#### Value Stack

Unlike traditional NEM, VDER Value Stack compensation is not based only on volumetric metering; the energy produced and exported to the grid will not be credited on the customer's utility bill at the same kWh rate at which energy is consumed. Instead, the Value Stack consists of six potential components and converts energy production into monetary credits that vary by location and time.

Value Stack credits are based on export into the utility grid. Solar generation that instantaneously reduces customer load will reduce the customer bill; generation that exceeds a customer's load behind the meter is exported to the grid and credited according to the Value Stack rates. For more information about VDER, including a description of all the components of the Value Stack, please visit our [Private Generation Tariffs webpage](#).

		Customer Name Account Number Billing Period State Date Billing Period End Date		[REDACTED] [REDACTED] 11/17/2017 12/20/2017
<b>Your account number:</b> [REDACTED] <b>Service delivered to:</b> [REDACTED] <b>Your electric rate:</b> EL9 General Large <b>Next billing date:</b> Wednesday, March 20, 2018		Billed consumption kWh 1602 Total Injections from DER kWh -1483.5		
<b>Your billing summary as of Feb 20, 2018</b>		<b>Value Stack Components</b>		
<b>Remaining balance</b> None		Energy Component \$/kWh \$ 0.03 Capacity Component \$/kWh \$ 0.01 Environmental Component \$/kWh \$ 0.02 Subtotal Credit per kWh \$/kWh \$ 0.07		
<b>Your new charges - details start on page 2</b> Billing period: Nov 17, 2017 to Dec 20, 2017 Electricity charges - for 33 days \$475.04 Adjustments -\$365.37 <b>Total new charges \$109.67</b>		Demand Reduction Value \$/kW-month (\$168.33) (monthly lump sum)		
<b>Total amount due \$109.67</b> Payment is due upon receipt of this bill. To avoid a late payment charge of 1.5%, please pay the total amount due by <b>Mar 13, 2018</b> .		Locational System Relief Value \$/kW-month \$ - (LSRV) (monthly lump sum)		
		Total credit per-kWh elements (\$197.04)		
		Total credit from DRV + LSRV (\$168.33)		
		Total Dollar Credit from DER this Billing Period (\$365.37)		
		<b>Credit Applied to Customer Bill</b>		
		Total Delivery Charges 320.77 Total Supply Charges 115.55 Total Miscellaneous Charges 38.72 Total Charges \$ 475.04 DER Credit (\$365.37) Remit to Utility \$ 109.67		
		Dollar Credits Carried Over from Previous Billing Period (if any) \$ -		
		Excess Dollar Credits Carrying Over to Next Billing Period \$ -		

Figure 6 - Example of Demand Customer Value Stack bill

### Important Net Metering Considerations

When evaluating your Net Metering options, there are several concepts that you should be familiar with: level billing, time of use, net meter vs. solar production meters, and demand customers.

#### Level Billing

Level billing is an option offered by Con Edison which allows a customer to spread their total expected annual energy costs over twelve equal monthly payments throughout the year. After installing a solar system, your total expected annual energy costs will be reduced by the solar output. It will take some time for your level payment plan to adjust to this lower energy use, and in the interim you will be putting more money toward your total expected annual energy costs than would actually be required. For this reason, upon completing your solar project you should call Con Edison (1-800-75-CONED) to be removed from the level billing plan. After a year off the program, you will have established your new lower total expected annual energy cost and can call us to re-join the level billing plan. Additional information on level billing can be found on Con Edison's website under [payment plans and assistance](#).

#### Time of Use Rates

Time of Use rates generally do not benefit solar-only customers, as solar credits remain in the on peak or off-peak "bucket" in which they are generated. Additional information can be found on Con Edison's website under [time of use rates](#).

### Net Meters vs. Production Meters

Net Metering billing is based on the excess energy sent back through the net meter, not the solar system production meter. The production meters that are typically provided by solar developers do not account for the energy drawn from the grid or the overall consumption of the premises.

### Additional Resources

For more information on any topics related to Solar Generation or the relevant billing structures, please visit:

- [Con Edison's Understanding Solar Video](#)
- [www.coned.com/solar](http://www.coned.com/solar)
- [Is Solar Right for Me?](#)
- [Solar FAQs](#)

## **Section 5: Solar Paired with Other Technologies**

When pairing PV systems with other Distribute Energy Resources and technologies, the technical considerations generally become more complex than can be covered in a high-level guide. However, the following are some frequently designed configurations along with the typical interconnection solution required to accommodate them. For general questions about a concept or potential project, developers can contact the DG Ombudsman's office for high-level feedback. For more specific information on configuration and feasibility, a formal interconnection request should be submitted.

- 1) Residential Solar system with energy storage as a backup – When a residential solar system is paired with an onsite energy storage system used solely for backup, the solar application should be submitted as a normal PV interconnection request in Power Clerk. The emergency back-up generator application (including lead-acid, lithium ion, etc.) should be submitted to the Project Center. An emergency back-up generator is defined as a generator that does not operate in parallel with the grid (never connects to the grid) via switching/control scheme.
- 2) Adding energy storage operated in parallel with the grid to an existing PV system – A new application should be submitted for the energy storage system by selecting 'Battery Energy Storage'. The inverter specifications should be entered for the battery in discharge mode. In addition, the technical specifications for charging the battery must be specified (peakkW-AC/KVA required to charge) in the scope of work statement, and if these exceed the local service, upgrades to the existing service may be required. Effective June 18, 2018, you will be asked on the initial application in Power Clerk to enter all information related to the battery in order to complete SIR Appendix K "Energy Storage System (ESS) Application Requirements / System Operating Characteristics / Market Participation."
- 3) Hybrid Solar – when applying for such systems, a single Hybrid application should be submitted for both technologies by using the Online Interconnection Application Portal ([PowerClerk](#)). You can start this application by choosing "New SIR Application >50kW (including Hybrid)" from the PowerClerk home screen. Even if all technologies are being installed by separate developers, a single combined system diagram may be required to enable engineering evaluation. For Hybrid

Solar systems which pair battery energy storage systems (BESS), you will be asked to enter all information related to the BESS in order to complete SIR Appendix K.

Addition of non-net meter eligible technologies, or technologies that receive credits under different structures than the PV to be installed, behind a single Con Edison meter will require specialized metering and/or relaying schemes to accommodate. Con Edison must be made aware of all DG technologies on site at the time of your initial request to add PV to avoid billing problems which could result in a loss or delay in receiving your Net Metering credits.

Residential and Small Commercial (SC 1 and SC 2) customers are eligible to pair grid-parallel energy storage with solar and take service under the Phase One NEM tariff.

### Section 6: Contacts for Further Questions

If you have questions about your specific project application, please contact your Energy Services Customer Project Manager (CPM). You will receive their contact information when you submit your application in Power Clerk.

For general questions regarding DG interconnection, please contact the Distributed Generation group at [dgexpert@coned.com](mailto:dgexpert@coned.com).

For residential billing questions, please contact [netmetering@coned.com](mailto:netmetering@coned.com) or 212-780-6600. For large/commercial customers please e-mail [dl-CCGNet-metering@coned.com](mailto:dl-CCGNet-metering@coned.com)

In addition, New York State Department of Public Service and the New York State Energy Research and Development Authority have dedicated “DG Ombudsmen” who can help answer questions. Their contact information is available at the [Department of Public Service, Interconnection Ombudsmen Effort](#).

### Section 7: Definitions and Acronyms

Acronym	Definition
SIR	Standardized Interconnection Requirements
SCADA	Supervisory Control and Data Acquisition
DNP3	Distributed Network Protocol
RNM	Remote Net Metering
CDG	Community Distributed Generation
DER	Distributed Energy Resources
CESIR	Coordinated Electric System Interconnection Review
VDER	Value of Distributed Energy Resources

**Section 8: List of Figures**

Figure 1	Electric Distribution System
Figure 2	Disconnect Switch and Existing Service Clearly Labelled
Figure 3	Existing Equipment and Interconnection Location Clearly Label
Figure 4	Interconnection Application Process for 50kW to 5MW Projects
Figure 5	Example of Grandfathered or Phase One Net Meter Credited Bill
Figure 6	Example of Demand Customer Value Stack Bill